

**Index**

**Headers & Junctions**

Headers - Layout & Part Number System.....	7.01.01
Dimensional Data - Headers.....	7.01.02
Junctions - Layout & Part Number System .....	7.01.03
Dimensional Data - Junctions .....	7.01.04
Typical Mounting Styles and Cross Sections.....	7.01.05
Manastrip Style Headers & Junctions .....	7.02.01
Dual Headers & Junctions .....	Consult Factory

BAR MANIFOLDS
TAPPING PLATES
VALVE ADAPTERS
SUBPLATES
SUBPLATES w/ CIRCUITS
COVER PLATES
<b>HEADERS/ JUNCTIONS</b>
DIN BODIES
ACCESSORIES
VALVE PACKS & CUSTOMS
TECHNICAL INFO

## Product Tips and Features

BAR  
MANIFOLDSTAPPING  
PLATESVALVE  
ADAPTERS

SUBPLATES

SUBPLATES  
w/  
CIRCUITSCOVER  
PLATESHEADERS/  
JUNCTIONSDIN  
BODIES

ACCESSORIES

VALVE PACKS  
& CUSTOMSTECHNICAL  
INFO

### Headers & Junctions

Header & Junction blocks are used to provide distribution or connection points in a fluid power piping system. Headers provide a common through port for multiple inlet or outlet ports at each station to be neatly connected together. Junctions offer termination points to join individual lines in order to change direction or combine/split flow with other lines at each station. In both cases they provide support to the piping system.

1. Standard materials are Aluminum, Ductile Iron, and Steel. Other materials including Stainless Steel, Brass and Nylon® are optionally available.
2. Special Finishes including Black Oxide, Electroless Nickel Plating or Anodizing are optionally available.
3. UNC mounting bolt kits are supplied as standard.
4. Top only or Top & Side mounting available.
5. Internal galleries are equal to or greater than the nominal port connection in order to minimize pressure drops and fluid velocities.
6. No variation in design layout for each Model regardless of Port Code.
7. Both Headers & Junctions are offered in odd and even number of stations up to 10. Contact factory for models with more stations.
8. Headers are offered in 0°, 90° and 180° configurations as standard. Special orders can be placed for the 270° configurations.
9. Junctions are offered in 90°, 180° and 270° configurations as standard.
10. Models with smaller ports than shown are available as non-standards. Contact factory for part numbers.
11. Optional spacing between ports available upon request. Contact factory for part numbers.
12. Optional port sizes and types such as Metric, BSPP and SAE Flanges Code 61 or 62 are available on request. Contact factory for part numbers.
13. Some models of Twin Headers and Junctions are available as a special. Contact factory for part numbers.

# Headers - Layout & Part Number System

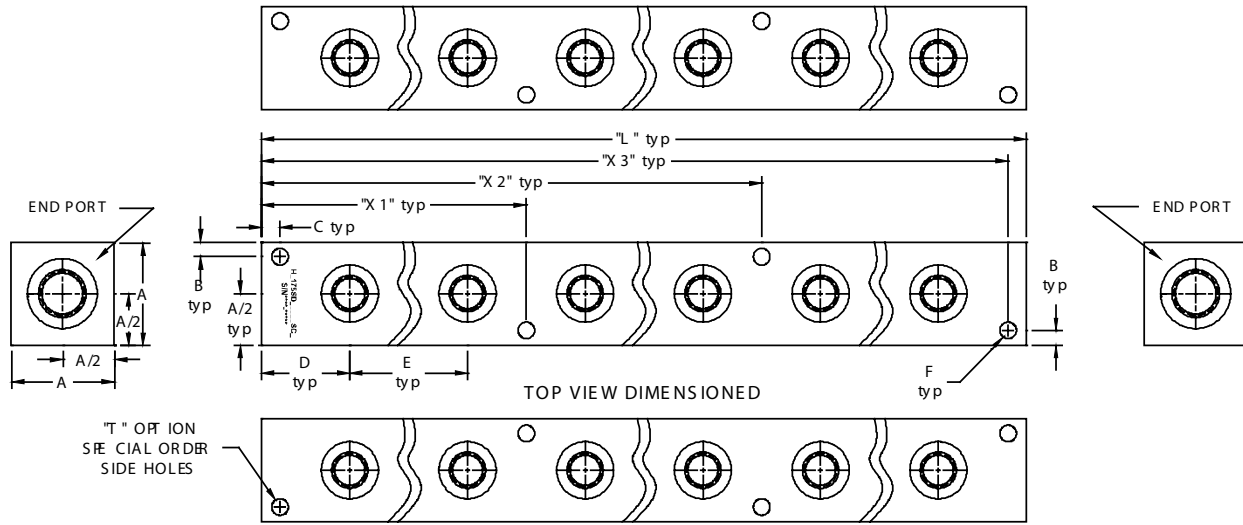

Note: End port must be 1 size larger than the side ports. Custom combinations available. Contact Lynch today. See page # 000 for our order form.  
To create a Part Number, select one CODE from each Column. Port sizes are linked to material size and must be selected from the same row for standard product.

**EXAMPLE** Aluminum Header with SAE 8 End Ports and SAE 6 Ports Out Top & One Side: HA175SD090\*\*SCU

TYPE	MAT'L	MATERIAL SIZE	END PORT CODE	PORT ORIENTATION	NO. of STATIONS	SIDE PORT CODE	MT'G																													
H HEADER	A OR F STEEL ALUMINUM D DUCTILE IRON	<table border="1"> <tr><th>CODE</th><th>SIZE</th></tr> <tr><td>100</td><td>1.00" x 1.00"</td></tr> </table>	CODE	SIZE	100	1.00" x 1.00"	<table border="1"> <tr><th>CODE</th><th>TYPE</th></tr> <tr><td>NA</td><td>1/8" NPTF</td></tr> </table>	CODE	TYPE	NA	1/8" NPTF	<table border="1"> <tr><th>CODE</th><th>STYLE</th></tr> <tr><td>000</td><td>One Side Only</td></tr> </table>	CODE	STYLE	000	One Side Only	01 to 10	<table border="1"> <tr><th>CODE</th><th>TYPE</th></tr> <tr><td>NR</td><td>1/16" NPTF</td></tr> </table>	CODE	TYPE	NR	1/16" NPTF	<table border="1"> <tr><td>STD</td><td>NON-STD</td></tr> <tr><td>U</td><td>or</td><td>T</td></tr> <tr><td>TOP</td><td>MTG</td><td>H</td><td>SIDE</td><td>MTG</td><td>H</td><td>ONLY</td><td>H</td></tr> </table>	STD	NON-STD	U	or	T	TOP	MTG	H	SIDE	MTG	H	ONLY	H
		CODE	SIZE																																	
		100	1.00" x 1.00"																																	
		CODE	TYPE																																	
		NA	1/8" NPTF																																	
		CODE	STYLE																																	
		000	One Side Only																																	
		CODE	TYPE																																	
		NR	1/16" NPTF																																	
		STD	NON-STD																																	
U	or	T																																		
TOP	MTG	H	SIDE	MTG	H	ONLY	H																													
<table border="1"> <tr><th>CODE</th><th>SIZE</th></tr> <tr><td>150</td><td>1.50" x 1.50"</td></tr> </table>	CODE	SIZE	150	1.50" x 1.50"	<table border="1"> <tr><th>CODE</th><th>TYPE</th></tr> <tr><td>NB</td><td>1/4" NPTF</td></tr> </table>	CODE	TYPE	NB	1/4" NPTF	<table border="1"> <tr><th>CODE</th><th>STYLE</th></tr> <tr><td>090</td><td>Top &amp; One Side</td></tr> </table>	CODE	STYLE	090	Top & One Side	<table border="1"> <tr><th>CODE</th><th>TYPE</th></tr> <tr><td>SB</td><td>SAE 4</td></tr> <tr><td>NB</td><td>1/4" NPTF</td></tr> </table>	CODE	TYPE	SB	SAE 4	NB	1/4" NPTF															
CODE	SIZE																																			
150	1.50" x 1.50"																																			
CODE	TYPE																																			
NB	1/4" NPTF																																			
CODE	STYLE																																			
090	Top & One Side																																			
CODE	TYPE																																			
SB	SAE 4																																			
NB	1/4" NPTF																																			
<table border="1"> <tr><th>CODE</th><th>SIZE</th></tr> <tr><td>175</td><td>1.75" x 1.75"</td></tr> </table>	CODE	SIZE	175	1.75" x 1.75"	<table border="1"> <tr><th>CODE</th><th>TYPE</th></tr> <tr><td>SC</td><td>SAE 6</td></tr> <tr><td>NC</td><td>3/8" NPTF</td></tr> </table>	CODE	TYPE	SC	SAE 6	NC	3/8" NPTF	<table border="1"> <tr><th>CODE</th><th>STYLE</th></tr> <tr><td>180</td><td>Two Opposite Sides</td></tr> </table>	CODE	STYLE	180	Two Opposite Sides	<table border="1"> <tr><th>CODE</th><th>TYPE</th></tr> <tr><td>SD</td><td>SAE 6</td></tr> <tr><td>NC</td><td>3/8" NPTF</td></tr> </table>	CODE	TYPE	SD	SAE 6	NC	3/8" NPTF													
CODE	SIZE																																			
175	1.75" x 1.75"																																			
CODE	TYPE																																			
SC	SAE 6																																			
NC	3/8" NPTF																																			
CODE	STYLE																																			
180	Two Opposite Sides																																			
CODE	TYPE																																			
SD	SAE 6																																			
NC	3/8" NPTF																																			
<table border="1"> <tr><th>CODE</th><th>SIZE</th></tr> <tr><td>175</td><td>1.75" x 1.75"</td></tr> </table>	CODE	SIZE	175	1.75" x 1.75"	<table border="1"> <tr><th>CODE</th><th>TYPE</th></tr> <tr><td>SD</td><td>SAE 8</td></tr> <tr><td>ND</td><td>1/2" NPTF</td></tr> </table>	CODE	TYPE	SD	SAE 8	ND	1/2" NPTF	<table border="1"> <tr><th>CODE</th><th>STYLE</th></tr> <tr><td>180</td><td>Two Opposite Sides</td></tr> </table>	CODE	STYLE	180	Two Opposite Sides	<table border="1"> <tr><th>CODE</th><th>TYPE</th></tr> <tr><td>SD</td><td>SAE 8</td></tr> <tr><td>ND</td><td>1/2" NPTF</td></tr> </table>	CODE	TYPE	SD	SAE 8	ND	1/2" NPTF													
CODE	SIZE																																			
175	1.75" x 1.75"																																			
CODE	TYPE																																			
SD	SAE 8																																			
ND	1/2" NPTF																																			
CODE	STYLE																																			
180	Two Opposite Sides																																			
CODE	TYPE																																			
SD	SAE 8																																			
ND	1/2" NPTF																																			
<table border="1"> <tr><th>CODE</th><th>SIZE</th></tr> <tr><td>200</td><td>2.00" x 2.00"</td></tr> </table>	CODE	SIZE	200	2.00" x 2.00"	<table border="1"> <tr><th>CODE</th><th>TYPE</th></tr> <tr><td>SF</td><td>SAE 12</td></tr> <tr><td>NF</td><td>3/4" NPTF</td></tr> </table>	CODE	TYPE	SF	SAE 12	NF	3/4" NPTF	<table border="1"> <tr><th>CODE</th><th>STYLE</th></tr> <tr><td>270</td><td>Top &amp; Two Opposite Sides</td></tr> </table>	CODE	STYLE	270	Top & Two Opposite Sides	<table border="1"> <tr><th>CODE</th><th>TYPE</th></tr> <tr><td>SF</td><td>SAE 12</td></tr> <tr><td>NF</td><td>3/4" NPTF</td></tr> </table>	CODE	TYPE	SF	SAE 12	NF	3/4" NPTF													
CODE	SIZE																																			
200	2.00" x 2.00"																																			
CODE	TYPE																																			
SF	SAE 12																																			
NF	3/4" NPTF																																			
CODE	STYLE																																			
270	Top & Two Opposite Sides																																			
CODE	TYPE																																			
SF	SAE 12																																			
NF	3/4" NPTF																																			
<table border="1"> <tr><th>CODE</th><th>SIZE</th></tr> <tr><td>250</td><td>2.50" x 2.50"</td></tr> </table>	CODE	SIZE	250	2.50" x 2.50"	<table border="1"> <tr><th>CODE</th><th>TYPE</th></tr> <tr><td>SH</td><td>SAE 16</td></tr> <tr><td>NH</td><td>1" NPTF</td></tr> </table>	CODE	TYPE	SH	SAE 16	NH	1" NPTF	<table border="1"> <tr><th>CODE</th><th>STYLE</th></tr> <tr><td>270</td><td>Top &amp; Two Opposite Sides</td></tr> </table>	CODE	STYLE	270	Top & Two Opposite Sides	<table border="1"> <tr><th>CODE</th><th>TYPE</th></tr> <tr><td>SH</td><td>SAE 16</td></tr> <tr><td>NH</td><td>1" NPTF</td></tr> </table>	CODE	TYPE	SH	SAE 16	NH	1" NPTF													
CODE	SIZE																																			
250	2.50" x 2.50"																																			
CODE	TYPE																																			
SH	SAE 16																																			
NH	1" NPTF																																			
CODE	STYLE																																			
270	Top & Two Opposite Sides																																			
CODE	TYPE																																			
SH	SAE 16																																			
NH	1" NPTF																																			
<table border="1"> <tr><th>CODE</th><th>SIZE</th></tr> <tr><td>300</td><td>3.00" x 3.00"</td></tr> </table>	CODE	SIZE	300	3.00" x 3.00"	<table border="1"> <tr><th>CODE</th><th>TYPE</th></tr> <tr><td>SI</td><td>SAE 20</td></tr> <tr><td>NI</td><td>1 1/4" NPTF</td></tr> </table>	CODE	TYPE	SI	SAE 20	NI	1 1/4" NPTF	<table border="1"> <tr><th>CODE</th><th>STYLE</th></tr> <tr><td>270</td><td>Top &amp; Two Opposite Sides</td></tr> </table>	CODE	STYLE	270	Top & Two Opposite Sides	<table border="1"> <tr><th>CODE</th><th>TYPE</th></tr> <tr><td>SI</td><td>SAE 20</td></tr> <tr><td>NI</td><td>1 1/4" NPTF</td></tr> </table>	CODE	TYPE	SI	SAE 20	NI	1 1/4" NPTF													
CODE	SIZE																																			
300	3.00" x 3.00"																																			
CODE	TYPE																																			
SI	SAE 20																																			
NI	1 1/4" NPTF																																			
CODE	STYLE																																			
270	Top & Two Opposite Sides																																			
CODE	TYPE																																			
SI	SAE 20																																			
NI	1 1/4" NPTF																																			
<table border="1"> <tr><th>CODE</th><th>SIZE</th></tr> <tr><td>350</td><td>3.50" x 3.50"</td></tr> </table>	CODE	SIZE	350	3.50" x 3.50"	<table border="1"> <tr><th>CODE</th><th>TYPE</th></tr> <tr><td>SJ</td><td>SAE 24</td></tr> <tr><td>NJ</td><td>1 1/2" NPTF</td></tr> </table>	CODE	TYPE	SJ	SAE 24	NJ	1 1/2" NPTF	<table border="1"> <tr><th>CODE</th><th>STYLE</th></tr> <tr><td>270</td><td>Top &amp; Two Opposite Sides</td></tr> </table>	CODE	STYLE	270	Top & Two Opposite Sides	<table border="1"> <tr><th>CODE</th><th>TYPE</th></tr> <tr><td>SI</td><td>SAE 20</td></tr> <tr><td>NI</td><td>1 1/4" NPTF</td></tr> </table>	CODE	TYPE	SI	SAE 20	NI	1 1/4" NPTF													
CODE	SIZE																																			
350	3.50" x 3.50"																																			
CODE	TYPE																																			
SJ	SAE 24																																			
NJ	1 1/2" NPTF																																			
CODE	STYLE																																			
270	Top & Two Opposite Sides																																			
CODE	TYPE																																			
SI	SAE 20																																			
NI	1 1/4" NPTF																																			
<table border="1"> <tr><th>CODE</th><th>SIZE</th></tr> <tr><td>400</td><td>4.00" x 4.00"</td></tr> </table>	CODE	SIZE	400	4.00" x 4.00"	<table border="1"> <tr><th>CODE</th><th>TYPE</th></tr> <tr><td>SK</td><td>SAE 32</td></tr> <tr><td>NK</td><td>2" NPTF</td></tr> </table>	CODE	TYPE	SK	SAE 32	NK	2" NPTF	<table border="1"> <tr><th>CODE</th><th>STYLE</th></tr> <tr><td>270</td><td>Top &amp; Two Opposite Sides</td></tr> </table>	CODE	STYLE	270	Top & Two Opposite Sides	<table border="1"> <tr><th>CODE</th><th>TYPE</th></tr> <tr><td>SJ</td><td>SAE 24</td></tr> <tr><td>NJ</td><td>1 1/2" NPTF</td></tr> </table>	CODE	TYPE	SJ	SAE 24	NJ	1 1/2" NPTF													
CODE	SIZE																																			
400	4.00" x 4.00"																																			
CODE	TYPE																																			
SK	SAE 32																																			
NK	2" NPTF																																			
CODE	STYLE																																			
270	Top & Two Opposite Sides																																			
CODE	TYPE																																			
SJ	SAE 24																																			
NJ	1 1/2" NPTF																																			

## Header Dimensional Data

### 1.00" HEADER

A	B	C	D	E	F
1.00	0.16	0.31	1.00	1.25	0.20

Mounting Kit includes:  
2 or 4 SHCS 10-24 UNC x 1.50" Long

### 1.50" HEADER

A	B	C	D	E	F
1.50	0.25	0.31	1.13	1.38	0.27

Mounting Kit includes:  
2 or 4 SHCS 1/4"-20 UNC x 2.00" Long

### 1.75" HEADER - STANDARD FLOW

A	B	C	D	E	F
1.75	0.25	0.31	1.06	1.75	0.27

Mounting Kit includes:  
2 or 4 SHCS 1/4"-20 UNC x 2.25" Long

### 1.75" HEADER - HIGH FLOW

A	B	C	D	E	F
1.75	0.25	0.31	1.50	2.00	0.27

Mounting Kit includes:  
2 or 4 SHCS 1/4"-20 UNC x 2.25" Long

### 2.00" HEADER

A	B	C	D	E	F
2.00	0.25	0.31	1.50	2.38	0.27

Mounting Kit includes:  
2 or 4 SHCS 1/4"-20 UNC x 2.50" Long

### 2.50" HEADER

A	B	C	D	E	F
2.50	0.28	0.38	1.81	3.25	0.34

Mounting Kit includes:  
2 or 4 SHCS 5/16"-18 UNC x 3.00" Long

### 3.00" HEADER

A	B	C	D	E	F
3.00	0.34	0.38	2.00	3.75	0.41

Mounting Kit includes:  
2 or 4 SHCS 3/8"-16 UNC x 3.75" Long

### 3.50" HEADER

A	B	C	D	E	F
3.50	0.41	0.50	2.25	4.00	0.53

Mounting Kit includes:  
2 or 4 SHCS 1/2"-13 UNC x 4.50" Long

### 4.00" HEADER

A	B	C	D	E	F
4.00	0.41	2.00	2.50	5.00	0.53

Mounting Kit includes:  
2 or 4 SHCS 1/2"-13 UNC x 5.00" Long

No. of Stations	1	2	3	4	5	6	7	8	9	10
Dim. "L"	2.00	3.25	4.50	5.75	7.00	8.25	9.50	10.75	12.00	13.25
X1	*	*	*	*	2.88	2.88	4.13	4.13	4.13	4.13
X2	*	*	*	*	4.13	5.38	5.38	6.63	7.88	9.13
X3	1.38	2.63	3.88	5.13	6.38	7.63	8.88	10.13	11.38	12.63

No. of Stations	1	2	3	4	5	6	7	8	9	10
Dim. "L"	2.25	3.63	5.00	6.38	7.75	9.13	10.50	11.88	13.25	14.63
X1	*	*	*	*	3.19	3.19	4.56	4.56	4.56	4.56
X2	*	*	*	*	4.56	5.94	5.94	7.31	8.69	10.06
X3	1.94	3.31	4.69	6.06	7.44	8.81	10.19	11.56	12.94	14.31

No. of Stations	1	2	3	4	5	6	7	8	9	10
Dim. "L"	2.13	3.88	5.63	7.38	9.13	10.88	12.63	14.38	16.13	17.88
X1	*	*	*	*	3.69	3.69	5.44	5.44	5.44	5.44
X2	*	*	*	*	5.44	7.19	7.19	8.94	10.69	12.44
X3	1.81	3.56	5.31	7.06	8.81	10.56	12.31	14.06	15.81	17.56

No. of Stations	1	2	3	4	5	6	7	8	9	10
Dim. "L"	3.00	5.00	7.00	9.00	11.00	13.00	15.00	17.00	19.00	21.00
X1	*	*	*	*	4.50	4.50	6.50	6.50	6.50	6.50
X2	*	*	*	*	6.50	8.50	8.50	10.50	12.50	14.50
X3	2.69	4.69	6.69	8.69	10.69	12.69	14.69	16.69	18.69	20.69

No. of Stations	1	2	3	4	5	6	7	8	9	10
Dim. "L"	3.00	5.38	7.75	10.13	12.50	14.88	17.25	19.63	22.00	24.38
X1	*	*	*	*	5.06	5.06	7.44	7.44	7.44	7.44
X2	*	*	*	*	7.44	9.81	9.81	12.19	14.56	16.94
X3	2.69	5.06	7.44	9.81	12.19	14.56	16.94	19.31	21.69	24.06

No. of Stations	1	2	3	4	5	6	7	8	9	10
Dim. "L"	3.63	6.88	10.13	13.38	16.63	19.88	23.13	26.38	29.63	32.88
X1	*	*	*	*	6.69	6.69	9.94	9.94	9.94	9.94
X2	*	*	*	*	9.94	13.19	13.19	16.44	19.69	22.94
X3	3.25	6.50	9.75	13.00	16.25	19.50	22.75	26.00	29.25	32.50

No. of Stations	1	2	3	4	5	6	7	8	9	10
Dim. "L"	4.00	7.75	11.50	15.25	19.00	22.75	26.50	30.25	34.00	37.75
X1	*	*	*	*	7.63	7.63	11.38	11.38	11.38	11.38
X2	*	*	*	*	11.38	15.13	15.13	18.88	22.63	26.38
X3	3.63	7.38	11.13	14.88	18.63	22.38	26.13	29.88	33.63	37.38

No. of Stations	1	2	3	4	5	6	7	8	9
Dim. "L"	4.50	8.50	12.50	16.50	20.50	24.50	28.50	32.50	36.50
X1	*	*	*	*	8.25	8.25	12.25	12.25	12.25
X2	*	*	*	*	12.25	16.25	16.25	20.25	24.25
X3	4.00	8.00	12.00	16.00	20.00	24.00	28.00	32.00	36.00

No. of Stations	1	2	3	4	5	6	7
Dim. "L"	8.00	13.00	18.00	23.00	28.00	33.00	38.00
X1	*	*	*	*	11.50	11.50	16.50
X2	*	*	*	*	16.50	21.50	21.50
X3	6.00	11.00	16.00	21.00	26.00	31.00	36.00

# Junctions - Layout & Part Number System

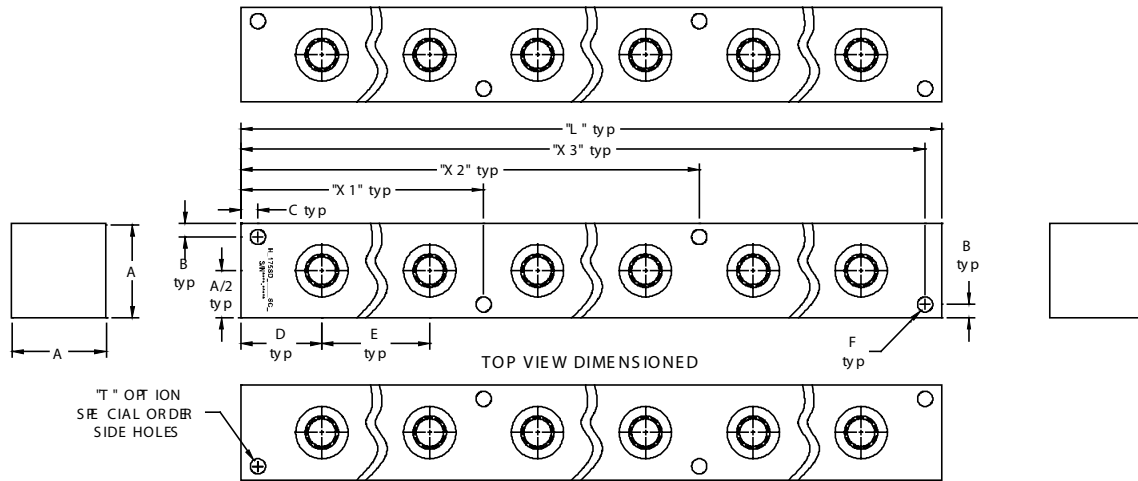

To create a Part Number, select one CODE from each Column. Port sizes are linked to material size and must be selected from the same row for standard product.

**EXAMPLE** Ductile Iron Junction with SAE 16 Ports Out Top & Two Opposite Sides: JD300XX270\*\*SHU

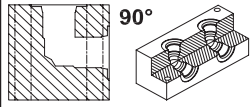
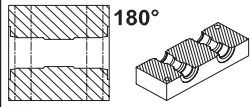
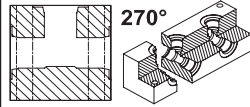
TYPE	MAT'L	MATERIAL SIZE	END PORT CODE	PORT ORIENTATION	NO. of STATIONS	SIDE PORT CODE	MT'G																				
J JUNCTION	A OR F STEEL OR ALUMINUM OR DUCTILE IRON	<table border="1"> <tr><th>CODE</th><th>SIZE</th></tr> <tr><td>100</td><td>1.00" x 1.00"</td></tr> </table>	CODE	SIZE	100	1.00" x 1.00"	<table border="1"> <tr><th>CODE</th><th>TYPE</th></tr> <tr><td>XX</td><td>NONE</td></tr> </table>	CODE	TYPE	XX	NONE	<table border="1"> <tr><th>CODE</th><th>STYLE</th></tr> <tr><td>090</td><td>Top &amp; One Side</td></tr> </table> 	CODE	STYLE	090	Top & One Side	01 to 10	<table border="1"> <tr><th>CODE</th><th>TYPE</th></tr> <tr><td>NR</td><td>1/16" NPTF</td></tr> </table>	CODE	TYPE	NR	1/16" NPTF	<table border="1"> <tr><td>STD</td><td>NON-STD</td></tr> <tr><td>U or T</td><td>TOP &amp; SIDE MTG HOLES ONLY</td></tr> </table>	STD	NON-STD	U or T	TOP & SIDE MTG HOLES ONLY
		CODE	SIZE																								
		100	1.00" x 1.00"																								
		CODE	TYPE																								
		XX	NONE																								
		CODE	STYLE																								
		090	Top & One Side																								
		CODE	TYPE																								
		NR	1/16" NPTF																								
		STD	NON-STD																								
U or T	TOP & SIDE MTG HOLES ONLY																										
<table border="1"> <tr><td>150</td><td>1.50" x 1.50"</td></tr> </table>	150	1.50" x 1.50"	<table border="1"> <tr><td>180</td><td>Two Opposite Sides</td></tr> </table> 	180	Two Opposite Sides	<table border="1"> <tr><td>SB</td><td>SAE 4</td></tr> <tr><td>NB</td><td>1/4" NPTF</td></tr> </table>	SB	SAE 4	NB	1/4" NPTF																	
150	1.50" x 1.50"																										
180	Two Opposite Sides																										
SB	SAE 4																										
NB	1/4" NPTF																										
<table border="1"> <tr><td>175</td><td>1.75" x 1.75"</td></tr> </table>	175	1.75" x 1.75"	<table border="1"> <tr><td>270</td><td>Top &amp; Two Opposite Sides</td></tr> </table> 	270	Top & Two Opposite Sides	<table border="1"> <tr><td>SC</td><td>SAE 6</td></tr> <tr><td>NC</td><td>3/8" NPTF</td></tr> </table>	SC	SAE 6	NC	3/8" NPTF																	
175	1.75" x 1.75"																										
270	Top & Two Opposite Sides																										
SC	SAE 6																										
NC	3/8" NPTF																										
<table border="1"> <tr><td>175</td><td>1.75" x 1.75"</td></tr> </table>	175	1.75" x 1.75"	01 to 09	<table border="1"> <tr><td>SD</td><td>SAE 8</td></tr> <tr><td>ND</td><td>1/2" NPTF</td></tr> </table>	SD	SAE 8	ND	1/2" NPTF																			
175	1.75" x 1.75"																										
SD	SAE 8																										
ND	1/2" NPTF																										
<table border="1"> <tr><td>200</td><td>2.00" x 2.00"</td></tr> </table>	200	2.00" x 2.00"		<table border="1"> <tr><td>SF</td><td>SAE 12</td></tr> <tr><td>NF</td><td>3/4" NPTF</td></tr> </table>	SF	SAE 12	NF	3/4" NPTF																			
200	2.00" x 2.00"																										
SF	SAE 12																										
NF	3/4" NPTF																										
<table border="1"> <tr><td>250</td><td>2.50" x 2.50"</td></tr> </table>	250	2.50" x 2.50"	<table border="1"> <tr><td>SH</td><td>SAE 16</td></tr> <tr><td>NH</td><td>1" NPTF</td></tr> </table>	SH	SAE 16	NH	1" NPTF																				
250	2.50" x 2.50"																										
SH	SAE 16																										
NH	1" NPTF																										
<table border="1"> <tr><td>300</td><td>3.00" x 3.00"</td></tr> </table>	300	3.00" x 3.00"	01 to 07	<table border="1"> <tr><td>SI</td><td>SAE 20</td></tr> <tr><td>NI</td><td>1 1/4" NPTF</td></tr> </table>	SI	SAE 20	NI	1 1/4" NPTF																			
300	3.00" x 3.00"																										
SI	SAE 20																										
NI	1 1/4" NPTF																										
<table border="1"> <tr><td>350</td><td>3.50" x 3.50"</td></tr> </table>	350	3.50" x 3.50"	<table border="1"> <tr><td>SJ</td><td>SAE 24</td></tr> <tr><td>NJ</td><td>1 1/2" NPTF</td></tr> </table>	SJ	SAE 24	NJ	1 1/2" NPTF																				
350	3.50" x 3.50"																										
SJ	SAE 24																										
NJ	1 1/2" NPTF																										
<table border="1"> <tr><td>400</td><td>4.00" x 4.00"</td></tr> </table>	400	4.00" x 4.00"																									
400	4.00" x 4.00"																										



## Typical Mounting Styles and Cross Sections

BAR  
MANIFOLDS

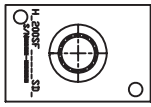

TAPPING  
PLATES

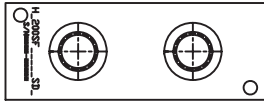

VALVE  
ADAPTERS

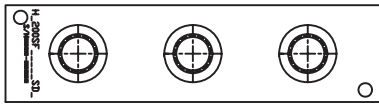

SUBPLATES

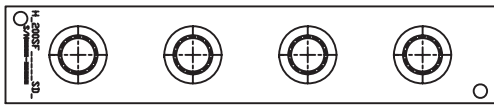

SUBPLATES  
w/ CIRCUITS

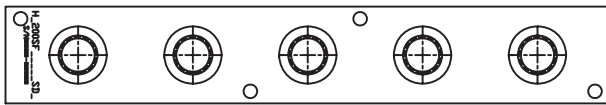

COVER  
PLATES

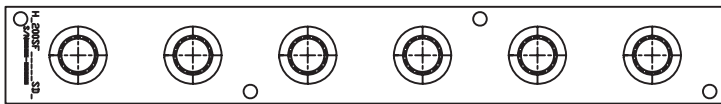

HEADERS/  
JUNCTIONS

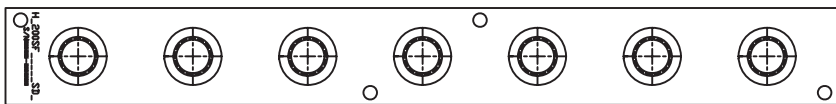

DIN  
BODIES

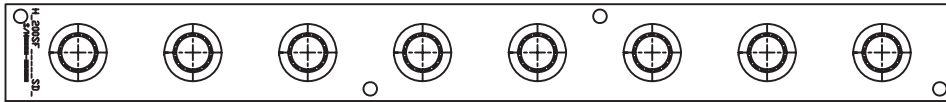

ACCESSORIES

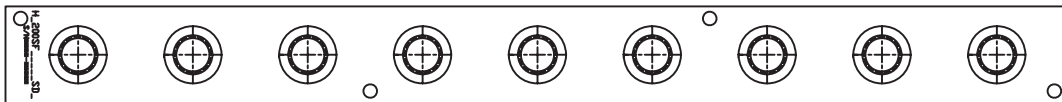

VALVE PACKS  
& CUSTOMS



TECHNICAL  
INFO

JUNCTIONS

HEADERS

